

PEMKO AUTOMATIC DOOR BOTTOM (ADB)

Experience a safer
and more open world

Applies to the following products:

STC4131™ Series

4131_PKL – Automatic, Non-Handed, Reversible

About Door Bottom Seals:

Pemko Door Bottom Seals consist of a variety of solutions for sealing a door to the threshold or floor surface.

About Automatic Door Bottoms:

Pemko Automatic Door Bottoms consist of an aluminum case which surrounds a movable drop bar seal. The drop bar seal is actuated by a plunger which contacts the jamb as the door is closing, forcing the drop bar seal down against the floor or threshold. Automatic Door bottoms are frequently used when an automatic door bottom is required to close over carpet.

- Low closing force.
- Provide excellent seals to keep out draft, dust, moisture, insects, fumes, light and sound.
- End plates provided for all mounting applications.

Product / Available Finishes:

STC4131CPK - Clear Anodized Aluminum with Black PemkoPrene® Insert

STC4131DPK - Dark Bronze Anodized Aluminum with Black PemkoPrene Insert

STC413110BEPK - Dark Oxidized Satin Bronze Equivalent with Black PemkoPrene Insert

STC4131BSPPK - Black Suede Powder Coat Aluminum with Black PemkoPrene Insert

STC4131WSPPK - White Suede Powder Coat Aluminum with Black PemkoPrene Insert

Testing/Ratings:

Gasketing material for fire doors intended for application to listed steel frames and/or classified steel covered composite type, and hollow metal type fire doors rated up to 3 hours; wood and plastic covered composite type fire doors rated up to 1 1/2 hours; and wood core type fire doors rated up to 20 minutes.

(Thresholds may or may not contain gasketing material).



Tools Required:

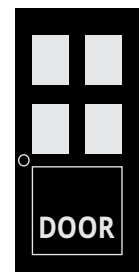
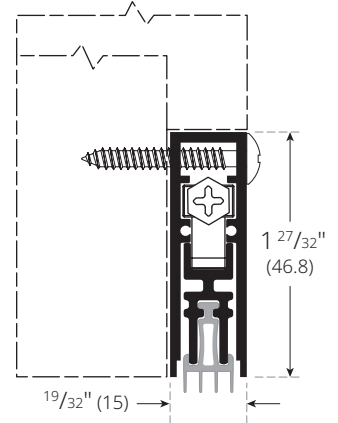
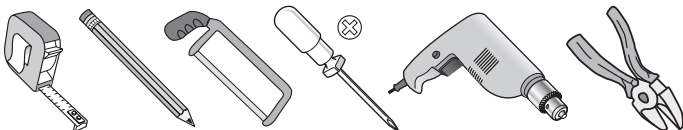

↑
Seals Bottom of Door

Parts Included:

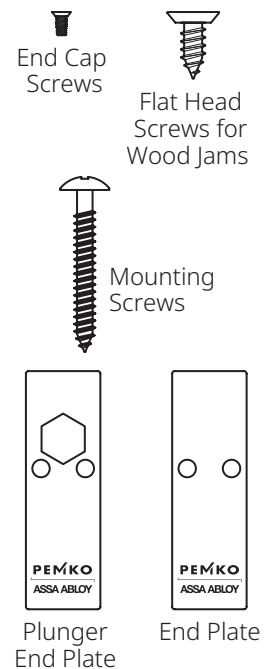

Installation instructions:

NOTE: If a door is fire labeled or of acoustical construction, semi-mortise preparation must be done by the door manufacturer or licensed machinist only.

NOTE: If the ADB is to be installed in a semi-mortise application, prepare door according to the dimensions shown in the profile drawing on front of label.

1. Determine if the application used is
 - a) Surface mounted or
 - b) Semi-mortised
2. Measure the distance:
 - a) Surface mounted: measure between frame stops
 - b) Semi-mortised: measure net door width
3. Cut the ADB (without cutting gasketing insert):
 - a) Surface mounted: cut ADB $\frac{1}{8}$ " less than the distance between the stops
 - b) Semi-mortised: cut ADB to door width

NOTE: When cutting, make sure that the drop bar is flush with the case on the plunger side. Do not trim the gasket yet.

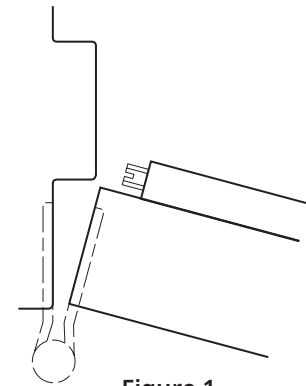

Figure 1
Surface Mounted

WARNING: ADB less than 24" CAN ONLY be cut down by $\frac{1}{2}$ ".

WARNING: ADB 24" and over should NOT be cut down more than 2".

WARNING: ADB should ONLY be cut from non-plunger side.

4. Adjust and trim the gasketing insert so that it fits fully in the case, between the end plates without dragging.
5. Place the ADB in the proper location on the door.
 - a) Surface mounted: the plunger contacts the stop (see Figure 1).
 - b) Semi-mortised: the plunger contacts the rabbet (see Figure 2).
6. Fasten with mounting screws provided.
 - a) The actuation plunger should be located on the hinge side of the door.
 - b) The bottom of the ADB case should be installed flush with the door bottom.
7. For wood jambs, a #10 x $\frac{1}{2}$ " flat head screw is furnished for installation at the point where the plunger contacts the jamb to prevent indenting.
8. Screw the actuating plunger in or out as required until the gasketing insert just touches the sealing surface when the door is closed.

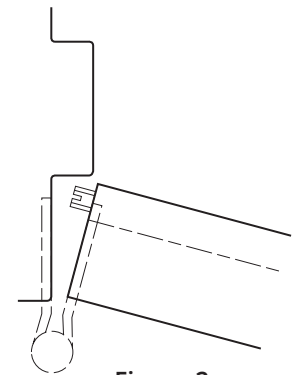

Figure 2
Semi-Mortise Mounted

NOTE: Adjustment range is $\frac{1}{8}$ " min - $\frac{3}{4}$ " max; recommended drop for optimal acoustic performance is $\frac{1}{2}$ ".

NOTE: Start with the plunger screwed in completely to avoid over adjustment or damage.

NOTE: Plunger extension to drop dimension is 1:1 (i.e., a $\frac{1}{4}$ " extension on the plunger will equal a $\frac{1}{4}$ " drop of the drop bar).

WARNING: Do not over adjust the plunger. It is only necessary to lightly compress the insert gaskets against the sealing surface to provide proper sealing. Over adjustment can cause internal component failure voiding the warranty!

WARNING: Do NOT use power tools to adjust the ADB!

The ASSA ABLOY Group is the global leader in access solutions. Every day, we help billions of people experience a more open world.

ASSA ABLOY Opening Solutions leads the development within door openings and products for access solutions in homes, businesses and institutions. Our offering includes doors, frames, door and window hardware, mechanical and smart locks, access control and service.

End Plate Installation Instructions:

PLEASE READ THESE INSTRUCTIONS THOROUGHLY BEFORE ATTEMPTING TO INSTALL END PLATES.

The automatic door bottom must be correctly installed and adjusted in accordance with the installation instructions furnished with this product (see other side).

1. Ensure the drop bar, which contains the gaskets, does not project beyond the case when the plunger is depressed.

WARNING: Under NO condition should the drop bar project beyond the edge of the case.

2. If necessary, re-trim the drop bar such that it is flush with the case on the non-plunger side when the plunger is depressed. Refer to instruction #3 (page 2) for Note and Warnings.
3. Install the end plate opposite the plunger, with the "This Side In" sticker towards the ADB, using the end plate screws as shown in Figure 4.

WARNING: Do NOT use power tools to tighten screws!

4. On the plunger side, with the "This Side In" sticker towards the ADB, align the end plate's hexagonal hole with the plunger and install using the end plate screws as shown in Figure 5.

NOTE: Plunger end plate prevents the plunger from rotating and changing adjustment. This plate may be removed for readjustment later if needed.



Figure 3 - Improper Drop Bar
This shows an improper drop bar protruding from the end of the case. The drop bar should be flush at both ends.

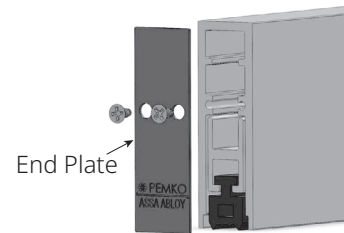

Figure 4 - Properly Installed End Plate
This shows a properly installed end plate.

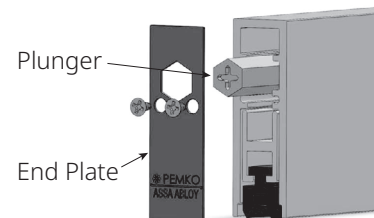

Figure 5
Plunger end plate prevents the plunger adjustment from rotating.