

5300/5500 DOOR CLOSER INSTRUCTION SHEET

PARALLEL ARM INSTALLATION - PUSH SIDE - NON-HOLD OPEN AND HOLD OPEN APPLICATIONS

INSTRUCTION: 539353

REV. 3

09-05-19

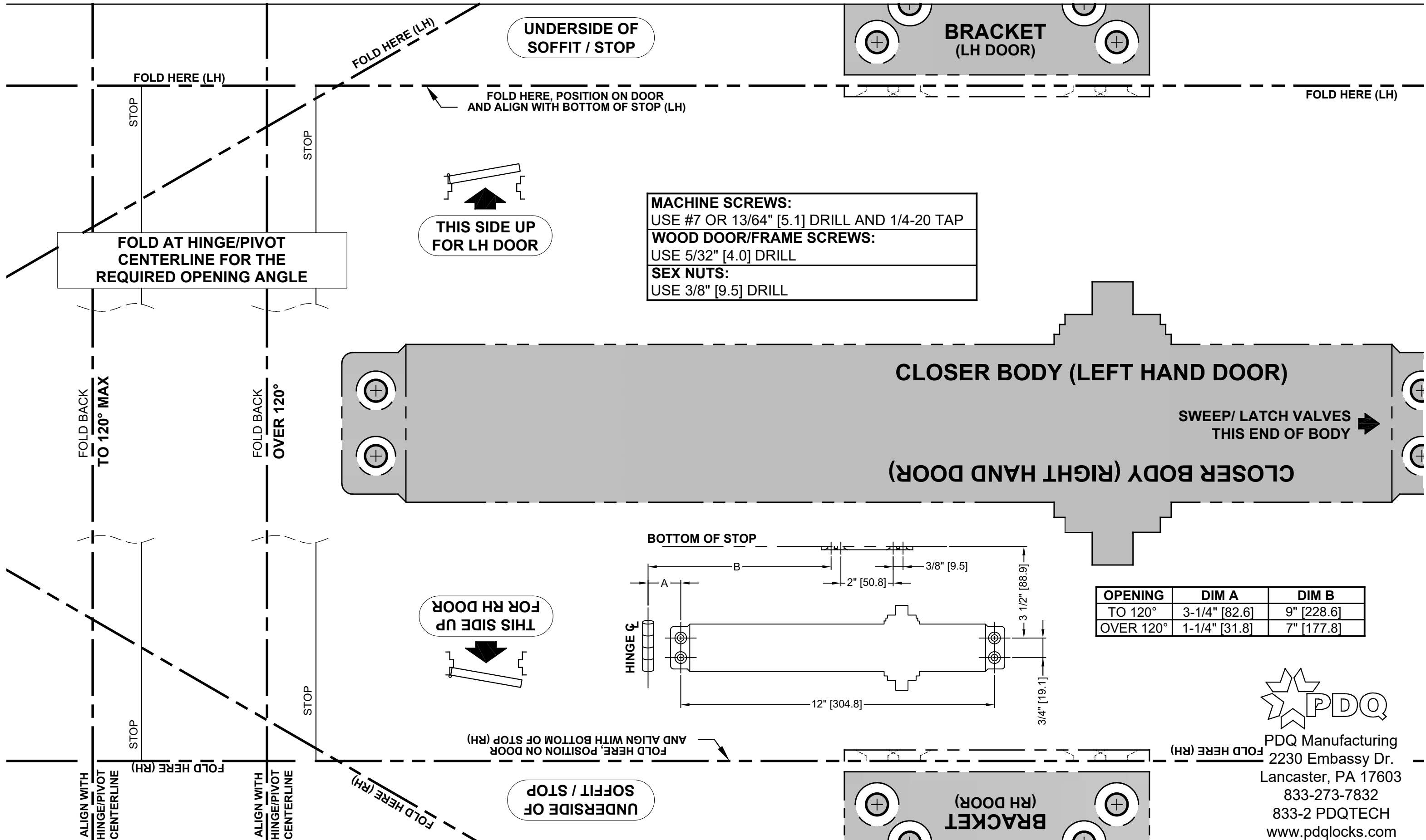

PDQ Manufacturing
2230 Embassy Dr.
Lancaster, PA 17603
833-273-7832
883-2 PDQTECH
www.pdqlocks.com

5300/5500 DOOR CLOSER INSTRUCTION SHEET

PARALLEL ARM INSTALLATION - PUSH SIDE - NON-HOLD OPEN AND HOLD OPEN APPLICATIONS

INSTRUCTION: 539353
REV. 3 09-05-19

- 1**
1. Confirm this sheet is correct for your product and application.
 2. Read the complete instruction sheet before starting installation.
 3. Incorrectly installed or adjusted door closers can cause personal injury or property damage.
 4. To ensure safe operation closers should be examined and serviced, regularly.

- 2**
1. See reverse side of this sheet to machine door & frame.
 2. Dimensions based on 4-1/2" x 4-1/2" full mortise butt hinges with 5/8" stop and 1/8" door gap.
 3. Confirm door & frame are properly reinforced.
 4. Sex nuts required for un-reinforced or composite fire doors.
 5. Do not install closer on the exterior (weather) side of building.

3 TOOLS REQUIRED:

1. Power drill
2. 10mm box/combo wrench
3. Phillips screw driver
4. #7 or 13/64" drill bit and 1/4-20 tap (machine screws)
5. Tap handle
6. 5/32" drill bit (wood screws)
7. 3/8" drill bit (sex nuts)
8. Center punch

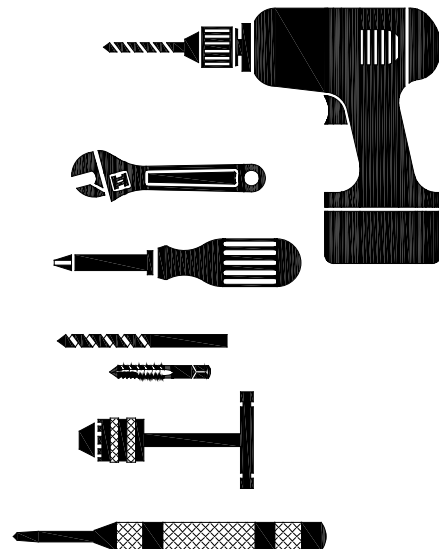

4 PREPARE DOOR AND FRAME:

1. Determine maximum opening angle.
2. Determine door hand (LH or RH).



3. Align & attach full size template (see reverse side).
4. Mark door & frame with center punch.
5. Remove template before machining door & frame.

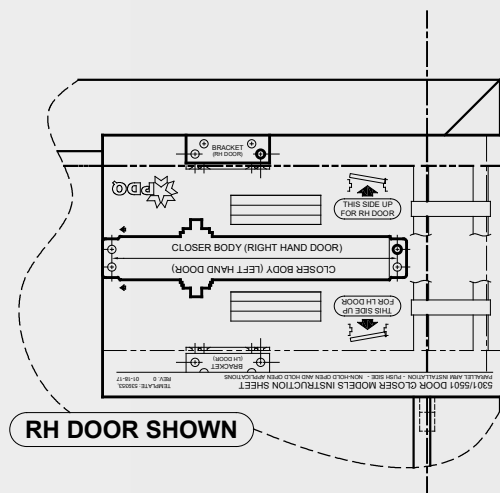

5 INSTALL CLOSER AND ARM:

1. Attach closer body to door. Sweep & latch valves point away from hinges.
2. Attach PA bracket to bottom of frame soffit.

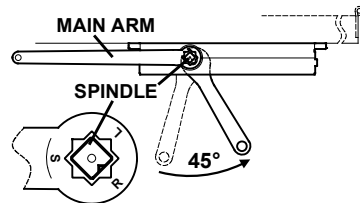
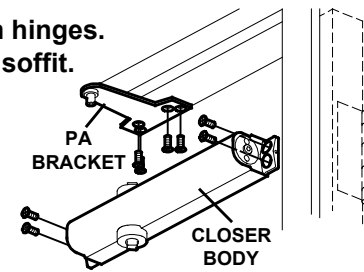

3. Rotate closer spindle 45° towards hinge / pivot.
4. Install main arm parallel to door face, pointing away from hinge or pivot.
5. Secure main arm to closer spindle.
6. Remove foot from connecting arm and install arm onto PA bracket.

8. Open door slightly and slide connecting arm into adjustment arm.
9. Close door.
10. Rotate main arm until it is approximately parallel to door.
11. Tighten arm screw or bolt.

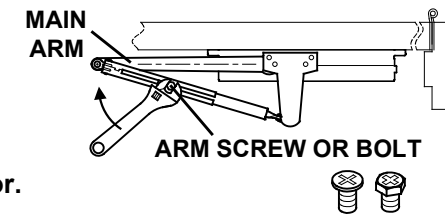

6 ADJUST SPRING POWER:

1. Use 4 mm hex key provided to adjust to size on chart. Clockwise (CW) turns increase spring power (+). Counter-clockwise (CCW) turns decrease spring power (-).

5300/5500 Series closers can be adjusted to meet ADA Barrier Free (BF) applications. Compliance with ADA/BF requirements may result with door not fully closing and latching. Check with local AHJ. Closer size may vary due to site conditions.

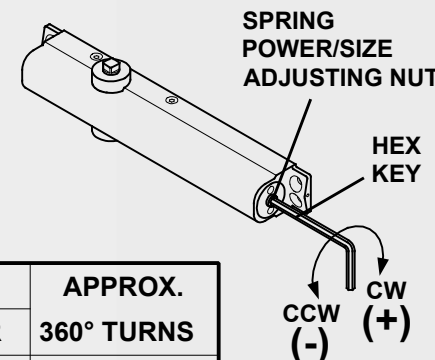

SIZE	DOOR WIDTH		APPROX. 360° TURNS
	INTERIOR	EXTERIOR	
BF	5 LBF ON 36"	--	-8 (CCW)
1	28" [711.2]	N/A	-6 (CCW)
2	32" [812.8]	28" [711.2]	-4 (CCW)
3	36" [914.4]	32" [812.8]	0 (PRESET)
4	42" [1066.8]	36" [914.4]	+5 (CW)
5	48" [1219.2]	42" [1066.8]	+9 (CW)
6	54" [1371.6]	48" [1219.2]	+12 (CW)

7 CONTROL ADJUSTMENTS:

Closing time of 3-7 seconds is typical. More time may be needed for ADA/BF access. Clockwise (CW) = SLOWER. Counter-clockwise (CCW) = FASTER. DO NOT REMOVE VALVES

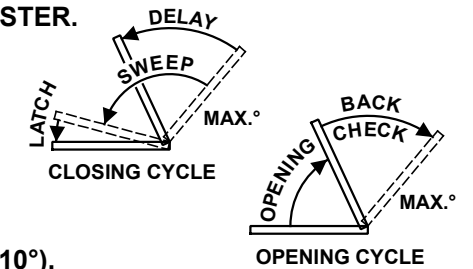

1. Use hex key provided.
2. Adjust SWEEP (closing max.° - 10°).
3. Adjust LATCH (closing 10° - 0°).
4. Adjust BACKCHECK resistance (opening 70° - max.°). DO NOT COMPLETELY CLOSE VALVE
5. Adjust (optional) DELAYED ACTION (closing max.° - 70°); Provides additional hesitation for access (ADA/BF) through door.

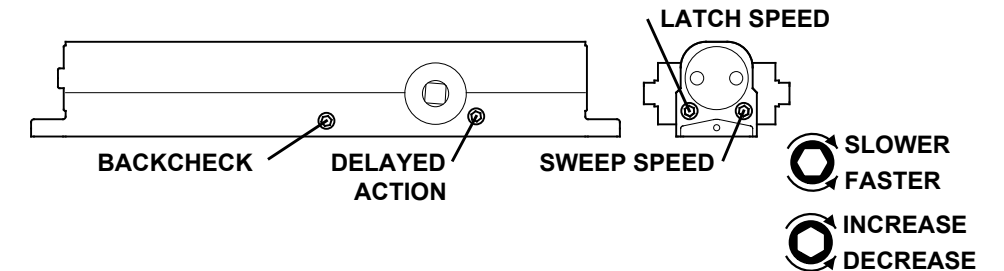

8 OPTIONAL HOLD OPEN ARM:

Important: Do not use arm as limiting stop, separate dead stop is required. Friction HO arm is not recommended for doors frequently operated in/out of hold open

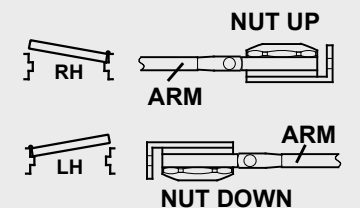

1. Install hold-open foot/nut. Left Hand (LH) door = Nut points down. Right Hand (RH) door = Nut points up.
2. Loosen HO nut.
3. Open door several degrees before HO position.
4. Tighten nut.

9 INSTALL COVER:

1. Slip cover over closer until flush with door face.
2. Wide Cover - Orient cover so cutout is at top of closer body. Secure to closer with screw on each end. Narrow Cover - Cover will snap into slots on closer body. Install dust cap over bottom closer pinion.

NOTE: Sweep, latch, backcheck, and optional delayed action valves are all accessible after cover installation.



PDQ Manufacturing
2230 Embassy Dr.
Lancaster, PA 17603
833-273-7832
833-2 PDQTECH
www.pdqlocks.com